

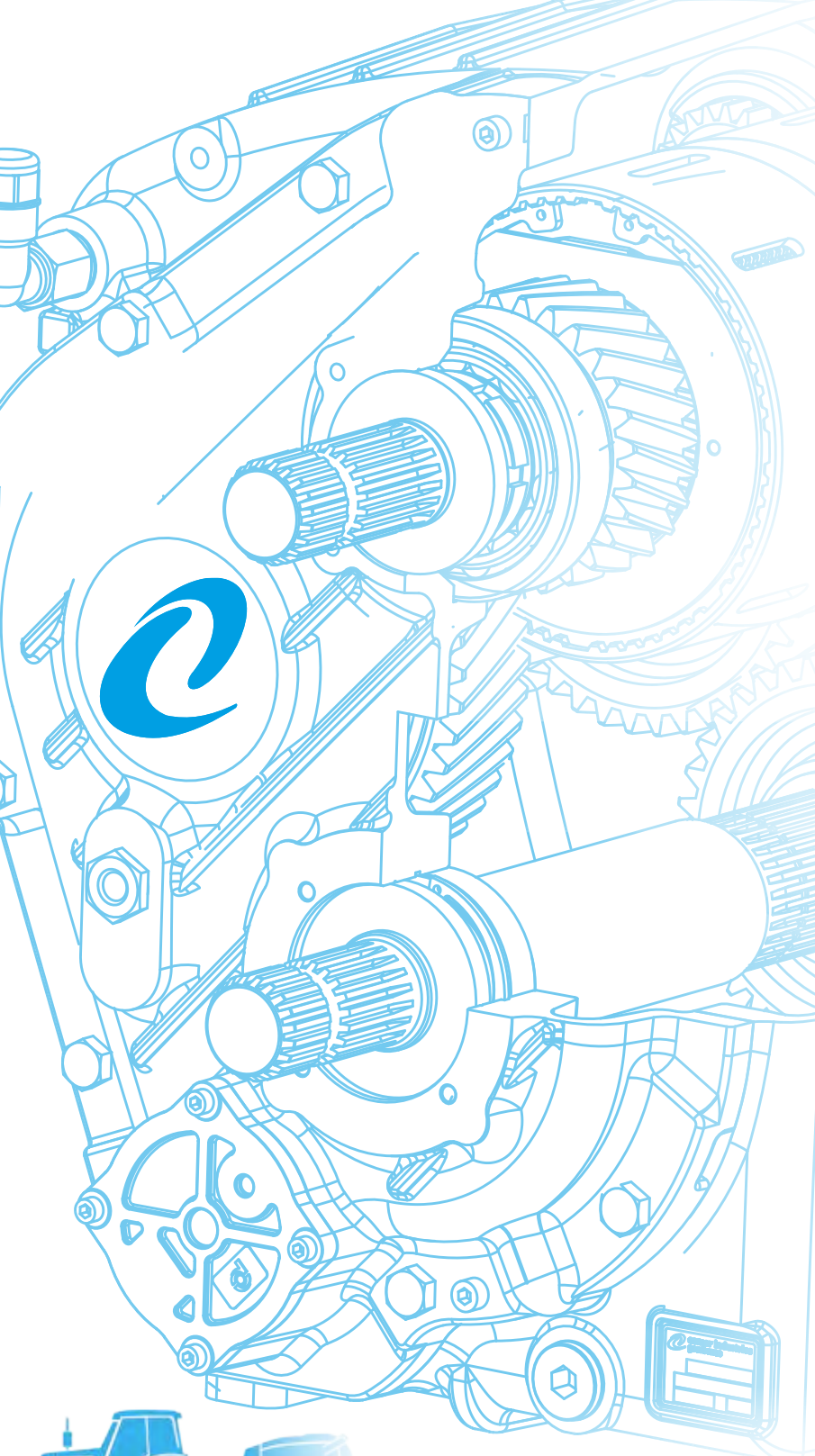



























**comer industries**



# GEARBOXES











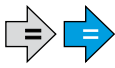
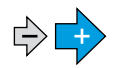
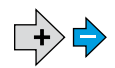

**The easiest way to go far in agriculture**

		Applicazioni <i>Applications</i>	p.
Profilo aziendale	<i>Company Profile</i>		4
<b>APPLICAZIONI STANDARD STANDARD APPLICATIONS</b>		(0.00)	
Gamma angolari applicazioni generiche	<i>Generic Application Angular Gearboxes</i>	 (0.01)	6
Gamma assi paralleli applicazioni generiche	<i>Generic Application Parallel Gearboxes</i>	 (0.02)	48
<b>MACCHINE PER LA PREPARAZIONE DEL TERRENO MACHINERY FOR LAND PREPARATION</b>		(1.00)	
Trinciastocchi	<i>Flail Mowers</i>	 (1.01)	64
Falciadistruggierba	<i>Rotary Mowers</i>	 (1.02)	84
Decespugliatrici	<i>Rotary Cutters</i>	 (1.03)	
Spandiletame	<i>Manure Spreaders</i>	 (1.04)	100
Decespugliatori idraulici	<i>Hydraulic Cutters</i>	 (1.05)	106
<b>MACCHINE PER LA LAVORAZIONE DEL TERRENO MACHINERY FOR SOIL TILLAGE</b>		(2.00)	
Zappatrici - Fresatrici	<i>Rotary Tillers</i>	 (2.01)	110
Zappatrici multiple	<i>Multiple Rotary Tillers</i>	 (2.02)	
Erpici rotanti	<i>Rotary Harrows</i>	 (2.03)	
Trivelle	<i>Post Hole Diggers</i>	 (2.04)	144
<b>MACCHINE PER IL TRATTAMENTO DELLE COLTURE MACHINERY FOR PLANT AND CROP TREATMENT</b>		(3.00)	
Atomizzatori	<i>Sprayers</i>	 (3.01)	150

			Applicazioni <i>Applications</i>	p.
<b>MACCHINE PER IL TRATTAMENTO DELLE COLTURE</b> <b>MACHINERY FOR PLANT AND CROP TREATMENT</b>			(3.00)	
	Spandiconcime	<i>Fertilizer Spreaders</i>	 (3.02)	160
	Pompe centrifughe per irrigazione	<i>Centrifugal Pumps for Irrigation</i>	 (3.03)	166
	Irrigatori a bobina	<i>Irrigation Reels</i>	 (3.04)	
<b>MACCHINE PER FIENAGIONE</b> <b>MACHINERY FOR FORAGE AND HAY</b>			(4.00)	
	Falciatrici rotative	<i>Cutter Bars</i>	 (4.01)	178
	Giroandanatori	<i>Rotary Rakes</i>	 (4.02)	190
	Spandifieno rotativi	<i>Rotary Tedders</i>	 (4.05)	
	Presse raccogliatrici	<i>Round Balers</i>	 (4.04)	204
<b>MACCHINE PER LA MISCELAZIONE E DISTRIBUZIONE FORAGGIO</b> <b>MACHINERY FOR MIXING AND DISTRIBUTION OF FORAGE</b>			(4.00)	
	Carri miscelatori	<i>Feed Mixer Machines</i>	 (4.06)	210
	Lancia paglia	<i>Straw Blower</i>	 (4.09)	
<b>MACCHINE PER TESTATE DA MAIS E CEREALI</b> <b>MACHINERY FOR CORN HEADER AND GRAIN HEADER</b>			(4.00)	
	Punte da mais	<i>Corn Headers</i>	 (4.06)	232
	Gruppi per testate da grano e girasoli	<i>Grain Header and Sunflower Headers</i>	 (4.10)	238
<b>APPLICAZIONI VARIE</b> <b>MISCELLANEOUS APPLICATIONS</b>			(5.00)	
	Gruppi elettrogeni	<i>P.T.O. Generators</i>	 (5.01)	244
	Seghe circolari - a nastro	<i>Circular Saws - Belt Saws</i>	 (5.02)	

			Applicazioni Applications	p.
<b>MIETITREBBIA E TRINCIA SEMOVENTE</b> <b>COMBINE AND FORAGE HARVESTER</b>			(6.00)	
Cinematismi per mietitrebbie	<i>Combine Harvester Solution</i>	 (6.01)	256	
Cinematismi per trincia semoventi	<i>Forage Harvester Driveline Solution</i>	 (6.02)	258	
Cinematismi per macchine semoventi	<i>Self-propelled Windrower Solution</i>	 (6.03)	260	
<b>INDICE ANALITICO</b> <b>ANALYTICAL INDEX</b>				262

i	Rapporto di riduzione <i>Reduction ratio</i>
	Rinvio <i>Gear unit 1:1 ratio</i>
	Moltiplicatore <i>Speed increasing unit</i>
	Riduttore <i>Speed reduction unit</i>
	Quantità lubrificante <i>Oil (or grease) quantity</i>
	
	Peso <i>Weight</i>

	Alberi scanalati maschio <i>Splined male shafts</i>
	Albero cilindrico maschio con linguetta <i>Cylindrical male shaft with key</i>
	Albero cilindrico femmina con linguetta <i>Cylindrical female shaft with key</i>
	Albero cilindrico maschio con fori ortogonali <i>Cylindrical male shaft with cross holes</i>
	Albero scanalato femmina <i>Splined female shafts</i>
	Albero conico maschio <i>Conical male shaft</i>
	Albero esagonale femmina <i>Hexagonal female shaft</i>

# L-150J

Code 150.8



(0.01)



[kg] 3.5

[kg] 0.2

Per configurazioni non a catalogo contattare Servizio Tecnico-Commerciale  
For non-catalog configurations contact Technical-Commercial Service

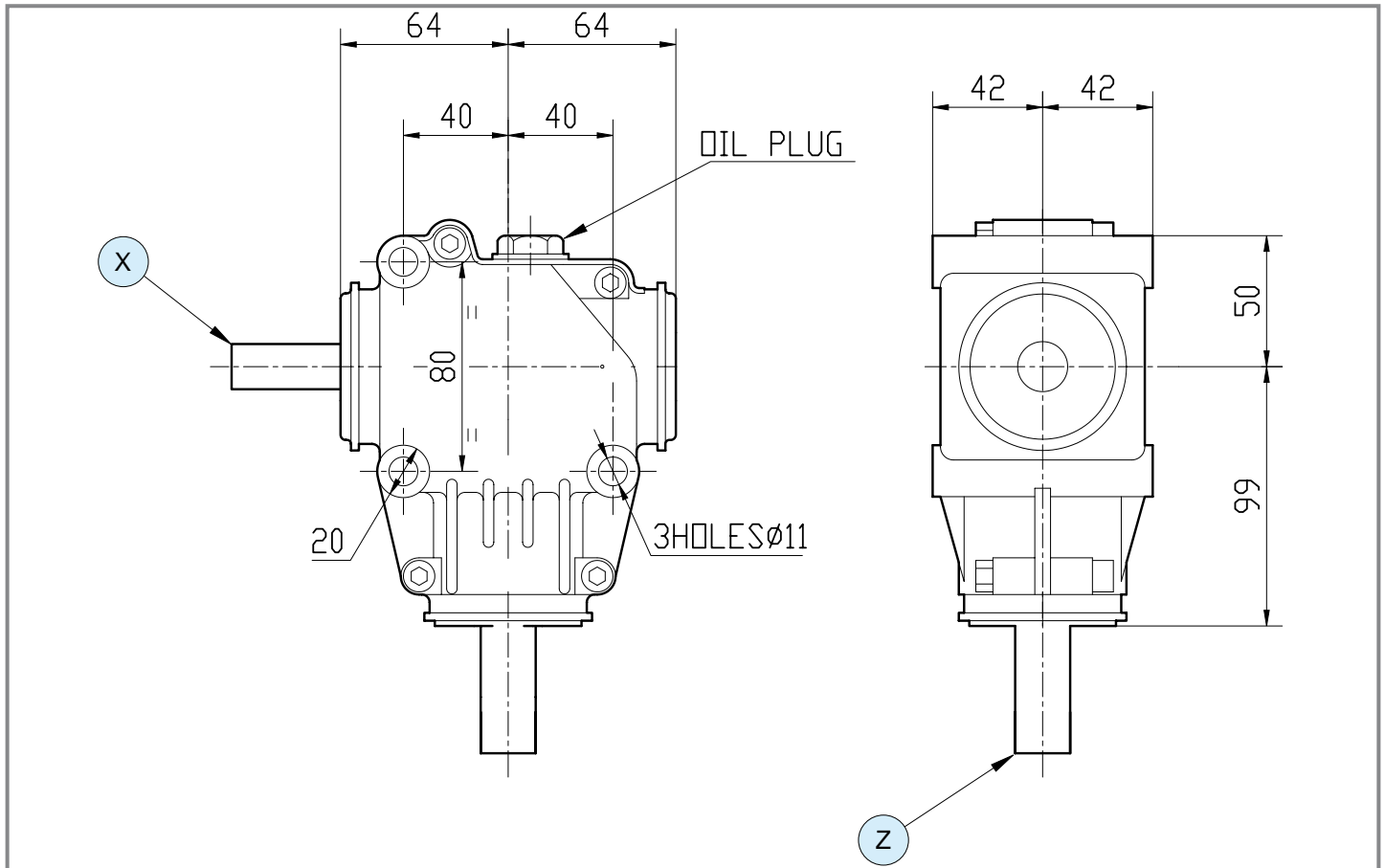

	i	N <sub>1</sub> [rpm]	P <sub>1</sub> [kW]	M <sub>2</sub> [Nm]	Shaft type			Input	Option	Code	Mounting	
					X	Y	Z					
-	1.00	540	8.0	137		-		Z	-	9.150.800		std
	1.00	540	8.0	137		-		Z	-	9.150.810		std
	1.00	540	8.0	137		-		Z	-	9.150.885		special

# L-150J

Code 150.8



	[kg]	3.5		[kg]	0.2
--	------	-----	--	------	-----

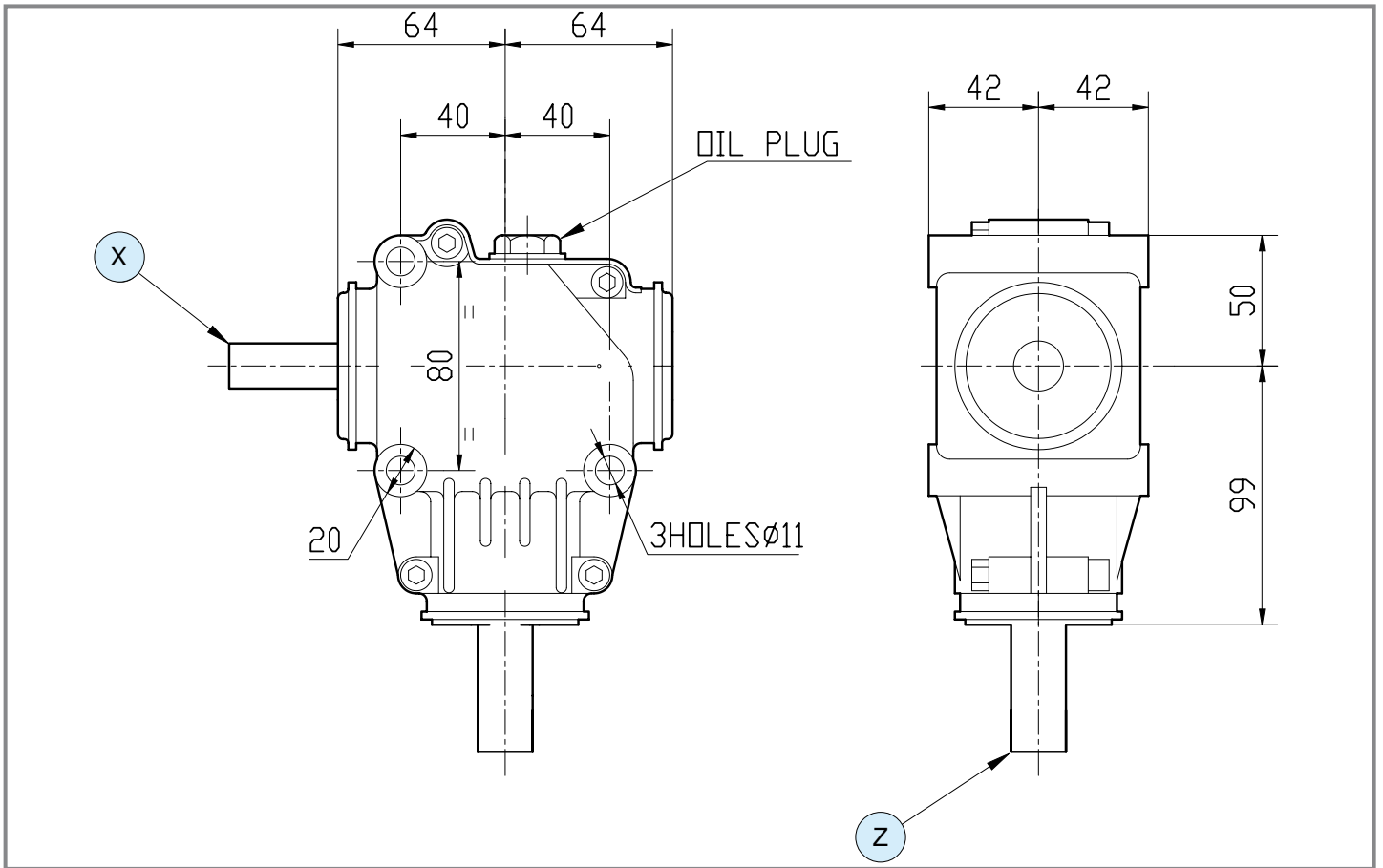

	i	N <sub>1</sub> [rpm]	P <sub>1</sub> [kW]	M <sub>2</sub> [Nm]	Shaft type			Input	Length	Code	Mounting	std
					X	Y	Z					
-	1	540	8	140		-		Z	-	9.150.800		

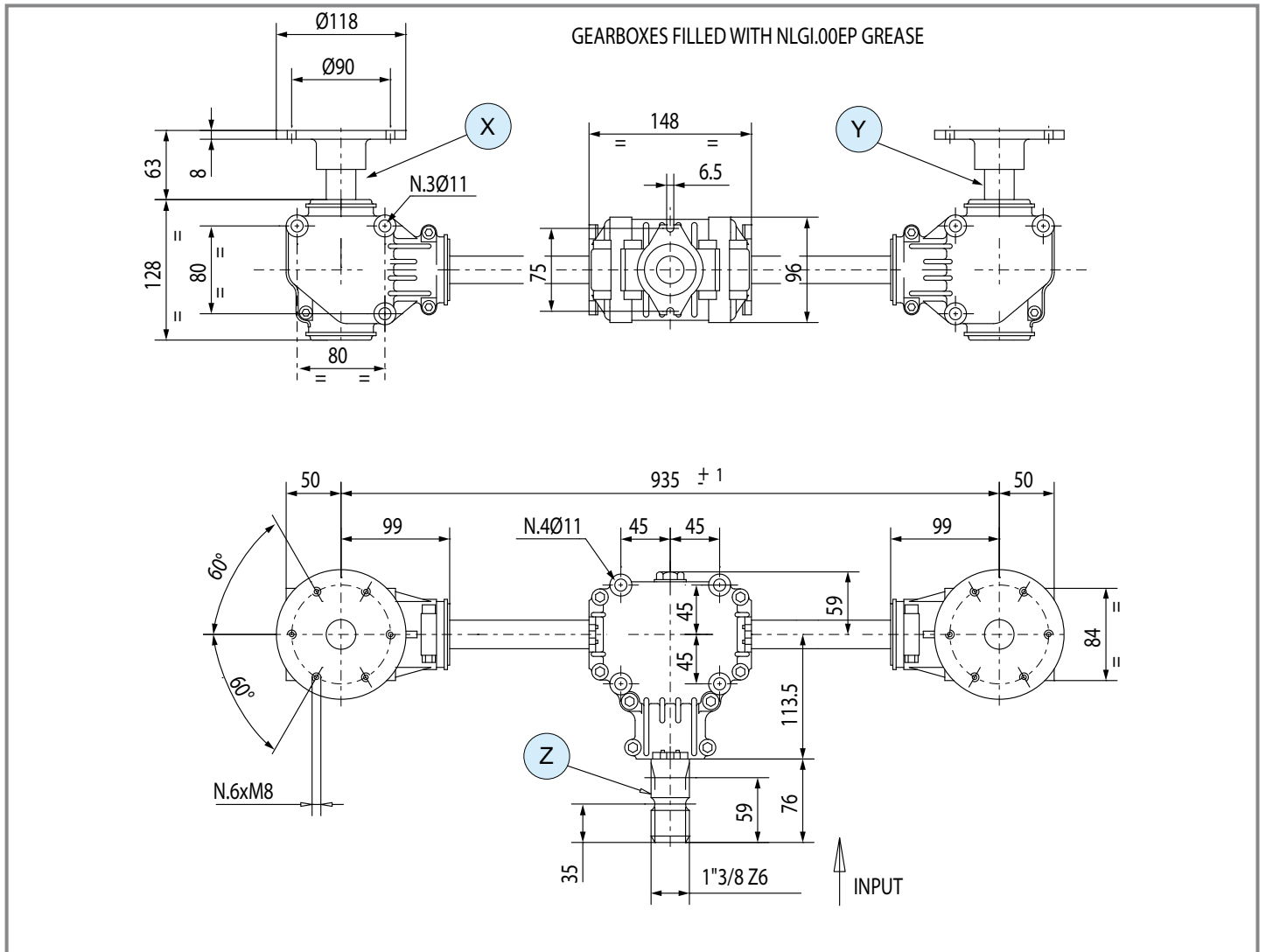

	i	N <sub>1</sub> [rpm]	P <sub>1</sub> [kW]	M <sub>2</sub> [Nm]	Shaft type			Input	Lenght	Code	Mounting	
					X	Y	Z					
	1.35	540	9.9	126				Z	935	9.150.013		std