

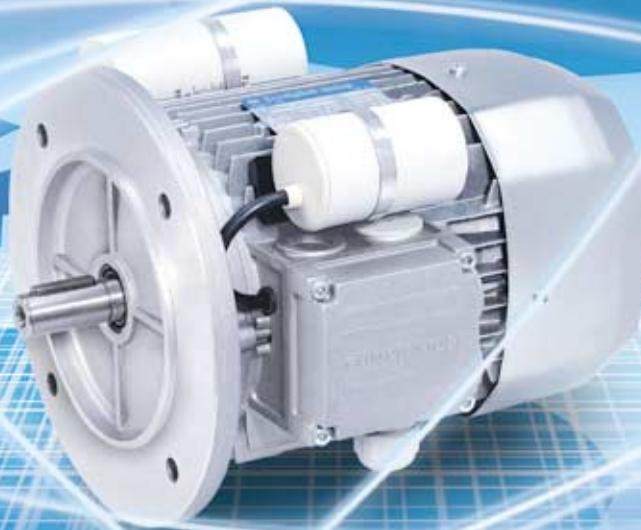

BS

1~



BONFIGLIOLI

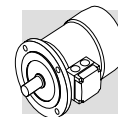

1.0 - GENERAL INFORMATION	2
1.1 - PRODUCT DESIGNATION	2
1.2 - STANDARDS	3
1.2.1 - Technical norms	3
1.2.2 - European directives CEE 73/23 (LVD) and CEE 89/336 (EMC)	3
1.3 - TOLERANCES	4
1.3.1 - Electrical tolerances	4
1.3.2 - Mechanical tolerances	4
2.0 - ELECTRICAL FEATURES	5
2.1 - OPERATING CONDITIONS	5
2.1.1 - Voltage	5
2.1.2 - Type of duty	5
2.1.3 - Ambient temperature	5
2.1.4 - Cooling	5
2.2 - CAPACITORS	5
2.3 - INSULATION CLASS	6
2.4 - THERMAL PROTECTION	6
2.5 - REVERSING	7
3.0 - MECHANICAL DESIGN	8
3.1 - BEARINGS	8
3.2 - TERMINAL BOX	8
3.3 - CABLE ENTRIES	8
3.4 - MOTOR MOUNTING	9
3.5 - DEGREE OF PROTECTION	9
3.6 - SECOND SHAFT EXTENSION AT NON-DRIVE END	10
3.7 - RAIN CANOPY	10
4.0 - RATING CHART	11
5.0 - DIMENSION DRAWINGS	12

Revisions

Refer to page 14 for the catalogue revision index. Visit www.bonfiglioli.com to search for catalogues with up-to-date revisions.

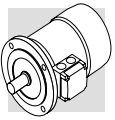

1.0 - GENERAL INFORMATION

1.1 - PRODUCT DESIGNATION

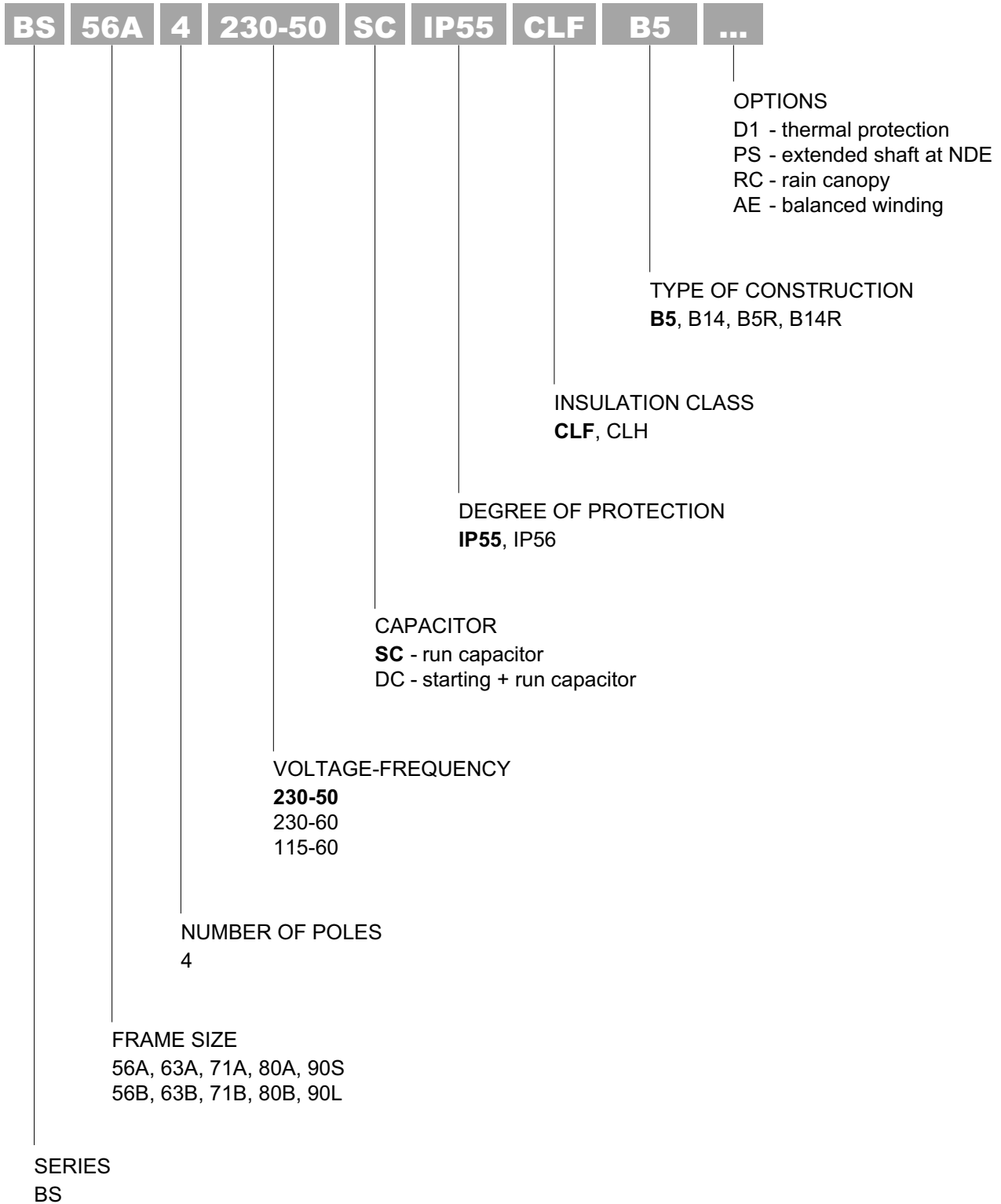

REMARK:

Values marked in **bold** represent the factory standard setting. If not otherwise specified at the time of order, for each variant the configuration marked in bold will be assumed.

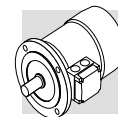

1.2 - STANDARDS

1.2.1 - Technical norms

Single-phase motors described in this catalog are of the enclosed type, fan ventilated and with run capacitor permanently connected.

Motors are designed for use in industrial environments and are manufactured in accordance with applicable CEI /EN and IEC standards as listed in the following table:

General requirements for rotating electrical machines	CEI EN 60034-1	IEC 60034-1
Dimensions and output ratings for rotating electrical machines	EN 50347	IEC 60072
Classification of degree of protection provided by enclosures for rotating machines	CEI EN 60034-5	IEC 60034-5
Methods of cooling for electrical machines	CEI EN 60034-6	IEC 60034-6
Classification of type of construction and mounting arrangements	CEI EN 60034-7	IEC 60034-7
Terminal markings and direction of rotation of rotating machines	CEI 2-8	IEC 60034-8
Noise limits	CEI EN 60034-9	IEC 60034-9
Rated voltage for low voltage mains power	CEI 8-6	IEC 60038

1.2.2 - European directives CEE 73/23 (LVD) and CEE 89/336 (EMC)

Bonfiglioli single-phase motors meet the requirements of Directives 73/23/EEC (Low Voltage Directive) and 89/336/EEC (Electromagnetic Compatibility Directive) and their nameplates bear the CE mark. As for the EMC Directive, construction is in accordance with standards CEI EN 60034-1 Sect. 12, EN 61000-6, EN 61000-6-2.

Motors also meet the requirements of standard CEI EN 60204-1 "Electrical equipment of machines".

The responsibility for final product safety and compliance with applicable directives rests with the manufacturer or the assembler who incorporate the motors as component parts.

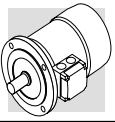

1.3 - TOLERANCES

1.3.1 - Electrical tolerances

The following tolerances are permitted according to CEI EN 60034-1:

Efficiency	$- 0.15 \times (1-\eta) \quad P \leq 50 \text{ kW}$
Power factor	$-\frac{1-\cos\phi}{6}$ [min 0.02 max 0.07]
Slip	$\pm 20\%$ (*)
Locked-rotor current	+ 20%
Locked-rotor torque	- 15% ...+ 25%
Breakdown torque	- 10%

(*) $\pm 30\%$ for motors with $P_n < 1\text{kW}$

1.3.2 - Mechanical tolerances

Dimensions and tolerances of shaft end, key and flange are in accordance with EN 50347, IEC 60072-1, CEI-UNEL 13501.

Shaft ends feature a threaded hole in accordance with UNI 3221, DIN 332. The shaft key is fitted in the key-way and supplied along with each motor.

The following table lists the tolerances for the different parts:

Part	Drawing letter	Tolerance
Shaft end	D - DA	j6
Key	F - FA	h9
Flange	N	j6

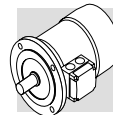

2.0 - ELECTRICAL FEATURES

2.1 - OPERATING CONDITIONS

2.1.1 - Voltage

In their standard configuration motors are designed for 230V-50Hz supply.
Upon request, motors can also be specified for 115V-60Hz or 230V-60Hz supply.

2.1.2 - Type of duty

Motor outputs listed in this catalogue refer to S1 continuous duty.

For motors operated at duties other than S1, as per Norms CEI EN 60034-1, please refer to Bonfiglioli's Technical Service for advise.



Single-phase motors have greater losses when they run idle than in full load operation.
Running idle for a long period is therefore NOT recommended.

2.1.3 - Ambient temperature

Catalog ratings are relevant to 50 Hz operation, under installation conditions as specified by standards CEI EN 60034-1 (temperature between -15 °C and + 40 °C and altitude above sea level \leq 1000 m).

2.1.4 - Cooling

Motors are cooled by external ventilation systems (IC 411 in accordance with CEI EN 60034-6) and are equipped with a plastic radial fan suitable for both directions of rotation.

Installation must take into account a minimum clearance of the fan cowl from the nearest wall so as to ensure unobstructed air circulation. This will also facilitate routine maintenance operations.

2.2 - Capacitors

Configuration with run capacitor

SC

Single-phase motors featuring the run capacitor only feature starting torque considerably lower than rated torque ($M_S = 30 - 70 \% M_N$) and are therefore only suitable for applications calling for low starting torque requirements.

Configuration with start and run capacitor

DC

For applications calling for higher starting torques, motors can be supplied with starting and run capacitors attached. In this case a starting torque $M_S = 140 - 170\% M_N$ will be allowed.

The starting capacitor is automatically cut off by the starter relay after approximately 1.5 seconds.



For letting the starting capacitor discharging allow for a minimum 6 seconds rest time before reconnecting the motor.

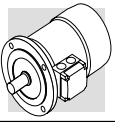

2.3 - INSULATION CLASS

Bonfiglioli motors use, as standard, class **F** insulating materials (enamelled wire, insulators, impregnation resins). For applications in the presence of aggressive chemicals or high humidity, contact Bonfiglioli Technical Service for assistance with product selection.

On request, motors to insulation class **H** can be specified.

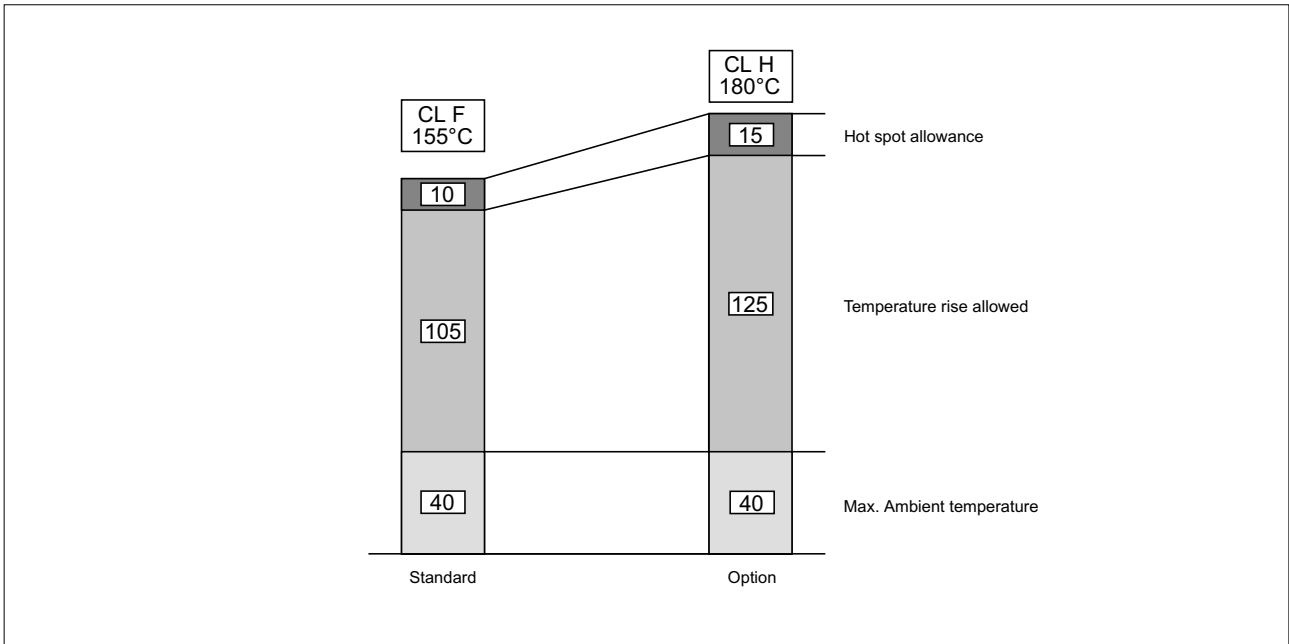

2.4 - THERMAL PROTECTION

Motors may be supplied with a built-in **thermal protector** preventing the stator windings from overheating due to poor ventilation or highly intermittent duty.

Thermal protectors consist of a bimetal disc that, when the rated temperature (150 °C) is reached, disconnects the contacts.

As the temperature decreases below the set value, the contacts are reconnected automatically.

Specify option **D1** in the ordering code

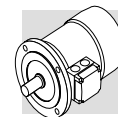

2.5 - REVERSING

Motors are supplied with run capacitor permanently connected and can be operated in both directions of rotation. Motors can be reversed by switching the wiring, as shown in the diagram below, through a remote control switch.

In the diagram below shaft are viewed from the drive end.

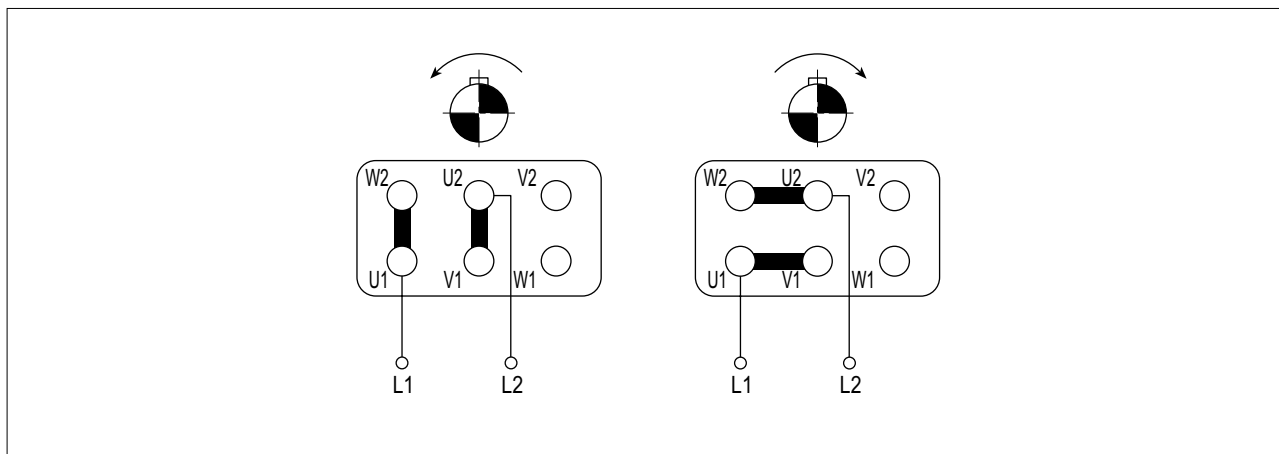

Prior to reversing, make sure the motor is at standstill.

AE

For a facilitated reversing through a simple switch, single-phase motors can be designed with symmetrical windings and run capacitor permanently connected.

For this arrangement specify option **AE** in the ordering code.

This particular design is lower rated as compare to the standard arrangement and advise should be seeked with Bonfiglioli's Technical Service.

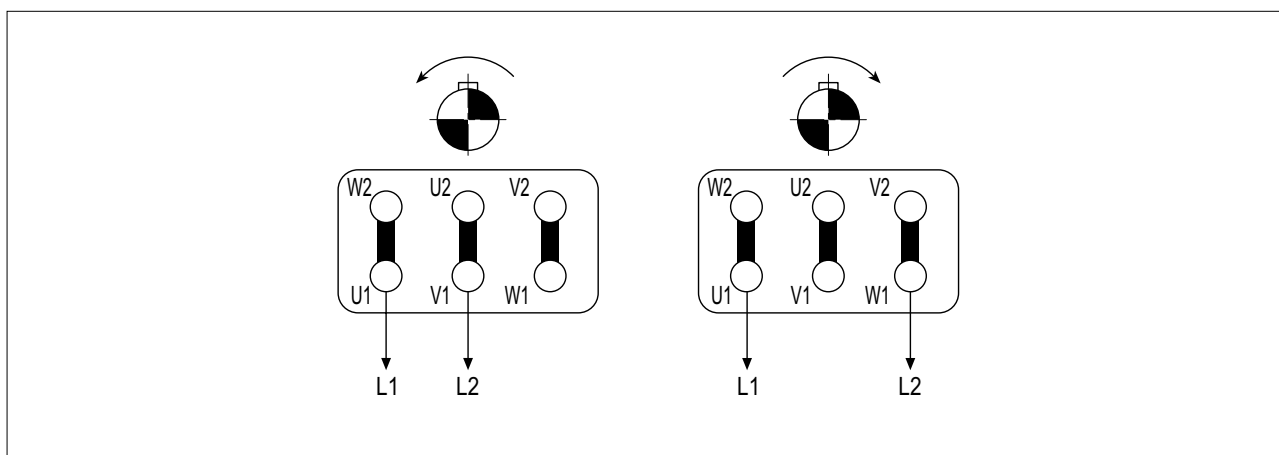

Prior to reversing, make sure the motor is at standstill.

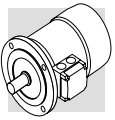

3.0 - MECHANICAL DESIGN

3.1 - BEARINGS

Grease-packed, axially locked ball bearings ensure maintenance free operation. Nominal endurance lifetime L_{10h} exceeds 40,000 hours assuming no overhung load on the shaft, and mounting position horizontal. The types of bearings in use are listed in the table below.

	DE	NDE
BS 56	6201 2Z C3	6201 2Z C3
BS 63	6201 2Z C3	6201 2Z C3
BS 71	6202 2Z C3	6202 2Z C3
BS 80	6204 2Z C3	6204 2Z C3
BS 90	6205 2Z C3	6205 2Z C3

3.2 - TERMINAL BOX

The main terminal box houses 6 terminals for cable lugs connection and the ground terminal for earth connection.

On wiring the motor, refer to the schemes that are either located in the terminal box or in the operating instructions.

3.3 - CABLE ENTRIES

Terminal boxes feature entries for metric-thread cable glands (not supplied) in accordance with standard CEI EN 50262. Dimensions and locations are as listed in the following table.

	cable entries and dimensions		cable \varnothing max. [mm]
BS 56 ... BS 63	2 x M20 x 1.5	on opposite sides	13
BS 71 ... BS 90	2 x M25 x 1.5		17

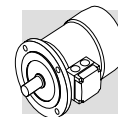

3.4 - MOTOR MOUNTING

Motors are available in the type of construction IM B5, IM B14 and derived versions in accordance with standard CEI EN 60034-7, as shown in the table below.

Motors may also be specified for vertical mounting, however the name plate will only show the corresponding basic design version:

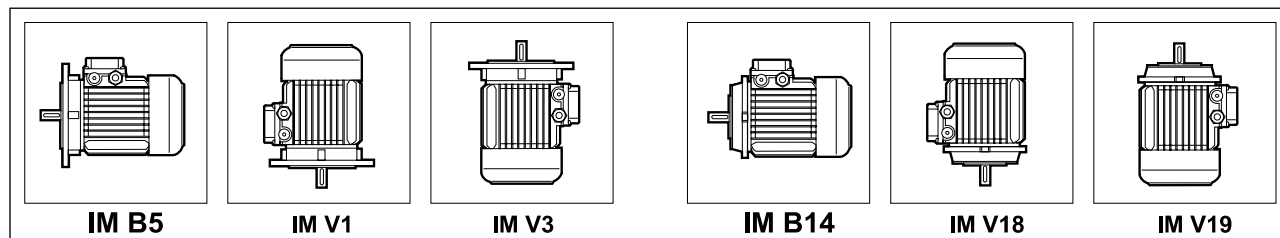

If motor is to be installed with the shaft end pointing down, the rain canopy is recommended and should be specified through the option **RC**.

Flanged motors can also be requested with reduced shaft and flange dimensions, specifying the design versions **B5R** or **B14R**.

Relevant dimensions are listed in the table below:

	BS 71	BS 80	BS 90
	D x E - Ø		
B5R ⁽¹⁾	11 x 23 - Ø 140	14 x 30 - Ø 160	19 x 40 - Ø 200
B14R ⁽²⁾	11 x 23 - Ø 90	14 x 30 - Ø 105	19 x 40 - Ø 120

- (1) flange con through holes
- (2) flange with threaded holes

3.5 - DEGREE OF PROTECTION

Standard motors are IP 55 protected. A higher degree of protection, IP56, is available on request.

Regardless to the degree of protection, motors for outdoors installation require extra protection against direct sunlight and in addition, when they are to be installed vertically down, a canopy protecting the motor from the ingress of water and solid bodies (option **RC**) must be specified.

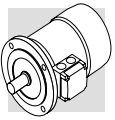

3.6 - SECOND SHAFT EXTENSION AT NON-DRIVE END

Specify option **PS** in the ordering code

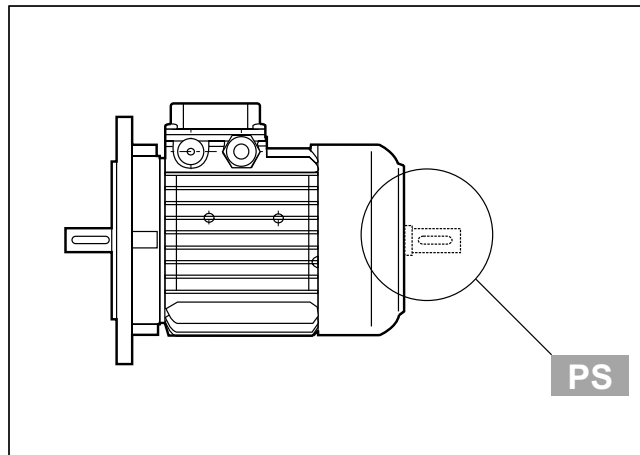

The option PS is not compatible with the rain canopy RC preventing the ingress of water and solid bodies. Refer to dimensional drawing for relevant shaft dimensions

3.7 - RAIN CANOPY



Option **RC**

The rain canopy is an optional device that protects the motor from the ingress of solid bodies and dripping water. It is highly recommended when motor is to be installed with the shaft end pointing down. Relevant dimensions are listed in the following table.

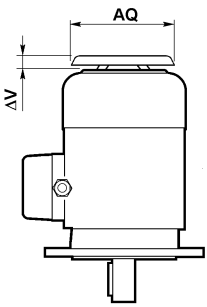
The canopy is not compatible with the second shaft extension, option PS.

	AQ	ΔV	
BS 63	118	24	
BS 71	134	27	
BS 80	134	25	
BS 90	168	30	

4.0 - RATING CHART

P _n kW		n min ⁻¹	M _n Nm	η %	cos φ	I _n (230 V) A	M _{max} /M _n	J _m ×10 ⁻⁴ kgm ²		SC			DC			
										I _s /I _n	M _s /M _n	C _{run} μF	I _s /I _n	M _s /M _n	C _{run} μF	C _{start} μF
0.06	BS 56A 4 BS 44B 4	1400	0.41	47	0.91	0.61	2	1.6	3.3	2.6	0.9	5	3.0	2.1	5	6.3
0.09	BS 56B 4 BS 27C 4 BS 44C 4	1350	0.64	51	0.98	0.78	1.6	1.6	3.3	2.0	0.7	6.3	2.3	1.9	6.3	10
0.12	BS 63A 4	1340	0.86	48	0.95	1.14	1.9	2.8	4.5	2.1	1.3	8	2.6	2.4	8	6.3
0.18	BS 63B 4	1280	1.34	49	0.87	1.84	1.6	3.4	5.1	1.8	0.9	8	2.6	2.0	8	10
0.25	BS 71A 4	1330	1.80	54	0.96	2.10	1.9	8.6	7	2.4	1.1	12.5	3.0	2.3	12.5	12.5
0.37	BS 71B 4	1310	2.7	56	0.96	2.99	1.7	9.6	7.6	2.2	1.0	16	2.8	2.1	16	16
0.55	BS 80A 4	1380	3.8	68	0.92	3.82	1.6	20	9.9	3.0	0.6	16	3.5	1.8	16	25
0.75	BS 80B 4	1360	5.3	67	0.95	5.12	1.6	25	11	2.9	0.6	25	3.5	1.7	25	30
1.1	BS 90S 4	1300	8.1	64	0.96	7.8	1.5	26	12.6	2.3	0.7	35	2.8	1.8	35	45
1.5	BS 90L 4	1300	11.0	64	0.95	10.7	1.5	31	15.1	2.5	0.5	40	3.0	1.6	40	45

Simb.	u.m.	Descrizione
C _{run}	μF	Capacity of run capacitor
C _{start}	μF	Capacity of starting capacitor
cos φ	–	Power factor
η	–	Efficiency
I _n	[A]	Rated current
I _s	[A]	Starting current
J _m	[kgm ²]	Motor moment of inertia

Simb.	u.m.	Descrizione
M _k	[Nm]	Breakdown torque
M _n	[Nm]	Rated torque
M _s	[Nm]	Starting torque
n	[min ⁻¹]	Rated speed
P _n	[kW]	Rated power
ta	[°C]	Ambient temperature

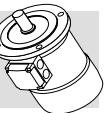

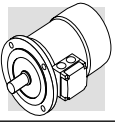

BS - IM B5

5.0 - DIMENSION DRAWINGS

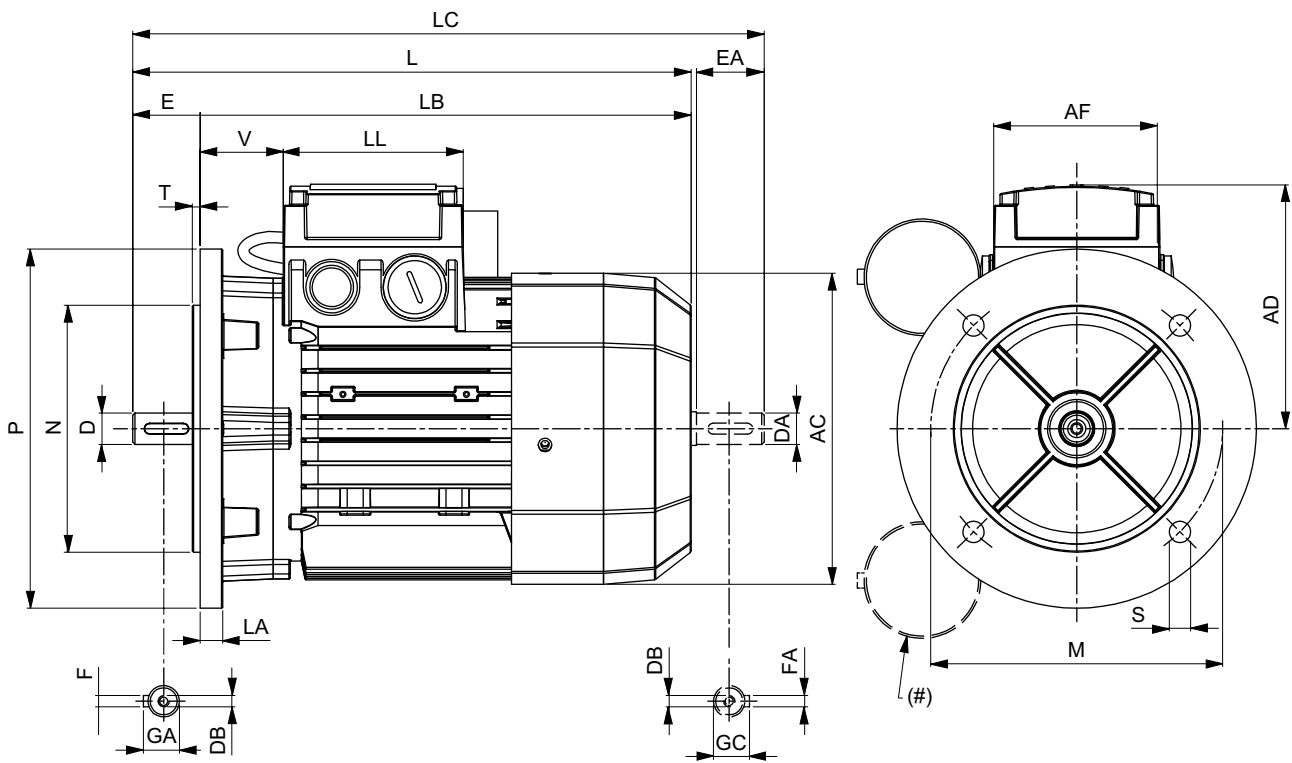

	SHAFT					FLANGE					MOTOR								
	D DA	E EA	DB	GA GC	F FA	M	N	P	S	T	LA	AC	L	LB	LC	AD	AF	LL	V
BS 56	9	20	M3	10.2	3	100	80	120	7	3	8	110	185	165	207	91	74	80	34
BS 63	11	23	M4	12.5	4	115	95	140	9.5		10	121	207	184	232	95			26
BS 71	14	30	M5	16	5	130	110	160	3.5	10	138	249	219	281	108	37			
BS 80	19	40	M6	21.5	6						156	274	234	315	119	38			
BS 90S	24	50	M8	27	8	165	130	200	11.5	3.5	11.5	176	326	276	378	133	98	98	44
BS 90L																			

(#) Starting capacitor - option DC.

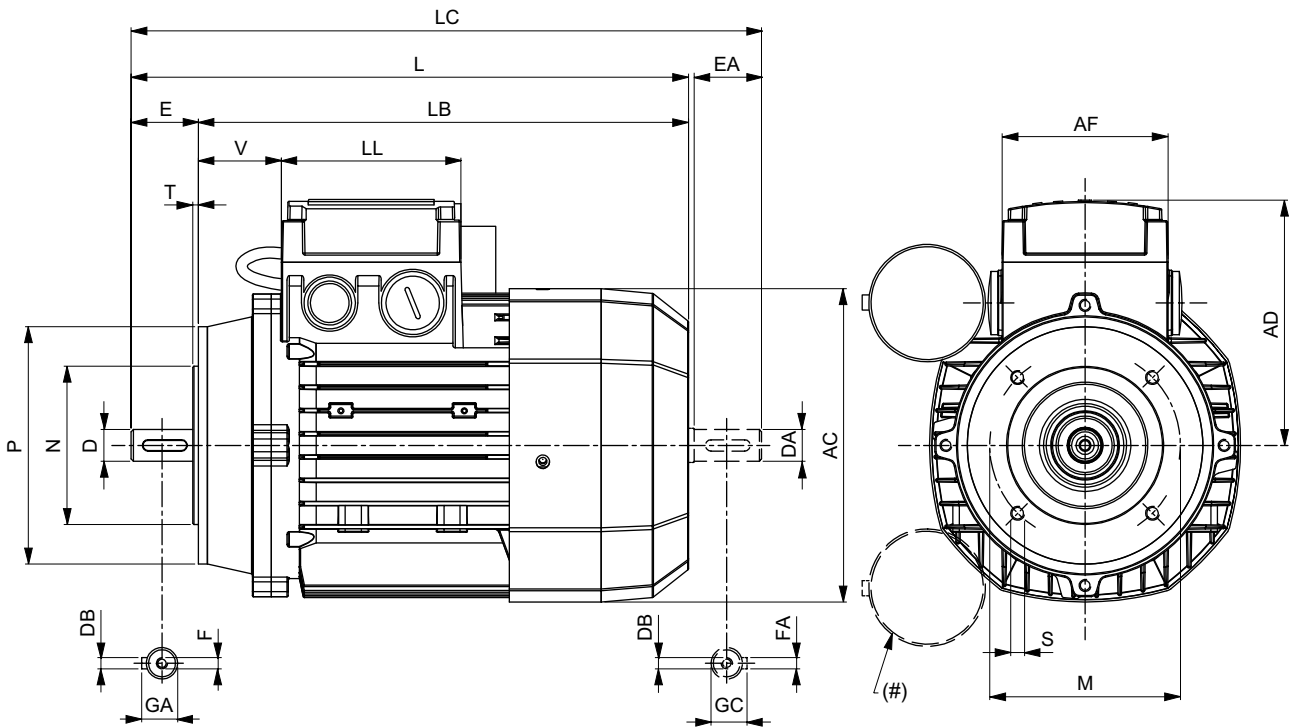
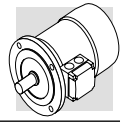

	SHAFT					FLANGE					MOTOR							
	D DA	E EA	DB	GA GC	F FA	M	N	P	S	T	AC	L	LB	LC	AD	AF	LL	V
BS 56	9	20	M3	10.2	3	65	50	80	M5	2.5	110	185	165	207	91	74	80	34
BS 63	11	23	M4	12.5	4	75	60	90			121	207	184	232				95
BS 71	14	30	M5	16	5	85	70	105	M6		138	249	219	281				108
BS 80	19	40	M6	21.5	6	100	80	120		156	274	234	315	119	38			
BS 90S	24	50	M8	27	8	115	95	140	M8	3	176	326	276	378	133	98	98	44
BS 90L																		

(#) Starting capacitor - option DC.

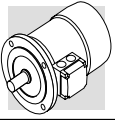

INDEX OF REVISIONS (R)

R0

We reserve the right to implement modifications without notice.
This catalogue cannot be reproduced, even partially, without prior consent.

Bonfiglioli Worldwide & BEST Partners

HEADQUARTERS

BONFIGLIOLI RIDUTTORI S.p.A.
Via Giovanni XXIII, 7/A
40012 Lippo di Calderara di Reno
Bologna (ITALY)
Tel. (+39) 051 6473111
Tel. (+39) 051 6473126
www.bonfiglioli.com
bonfiglioli@bonfiglioli.com

SPARE PARTS BONFIGLIOLI

B.R.T.
Via Castagnini, 2-4
Z.I. Bargellino - 40012
Calderara di Reno - Bologna (ITALY)
Tel. (+39) 051 727844
Fax (+39) 051 727066
www.brtbonfigliolicambi.it
brt@bonfiglioli.com

AUSTRALIA

BONFIGLIOLI TRANSMISSION (Aust) Pty Ltd.
48-50 Adderley St. (East) Auburn (Sydney) N.S.W. 2144
Tel. (+61) 2 8748 4400 - Fax (+61) 2 9748 8740
P.o. Box 6705 Silverwater NSW 1811
www.bonfiglioli.com.au - sales@bonfiglioli.com.au

AUSTRIA

MOLL MOTOR GmbH
Industriestrasse 8 - 2000 Stockerau
Tel. (+43) 2266 63421+DW - Fax (+43) 6342 180
Tlx 61 32 22 348 Molla
www.mollmotor.at - office@mollmotor.at

BELGIUM

N.V. ESCO TRANSMISSION S.A.
Culliganlaan 3 - 1831 Machelem Diegem
Tel. 0032 2 7204880 - Fax 0032 2 7212827
Tlx 21930 Escopo B
www.escotrans.be - info@escotrans.be

BRASIL

ATI BRASIL
Rua Omlio Monteiro Soares, 260 - Vila Fanny - 81030-000
Tel. (+41) 334 2091 - Fax (+41) 332 8669
www.atibrasil.com.br - vendas@atibrasil.com.br

CANADA

BONFIGLIOLI CANADA INC.
2-7941 Jane Street - Concord, ONTARIO L4K 4L6
Tel. (+1) 905 7384466 - Fax (+1) 905 7389833
www.bonfigliolicanada.com - sales@bonfigliolicanada.com

CHINA

BONFIGLIOLI DRIVES (SHANGHAI) CO. LTD.
No. 8 Building, 98 Tian Yng Road
Qingpu District, Shanghai, PRC 201700
Tel. +86 21 69225500 - Fax +86 21 69225511
www.bonfiglioli.cn - linkn@bonfiglioli.com.cn

FRANCE

BONFIGLIOLI TRANSMISSIONS S.A.
14 Rue Eugène Pottier BP 19
Zone Industrielle de Moimont II - 95670 Marly la Ville
Tel. (+33) 1 34474510 - Fax (+33) 1 34688800
www.bonfiglioli.fr - btf@bonfiglioli.fr

GERMANY

BONFIGLIOLI DEUTSCHLAND GmbH
Hamburger Straße 18 - 41540 Dormagen
Tel. (+49) 2133 50260 - Fax (+49) 2133 502610
www.bonfiglioli.de - info@bonfiglioli.de

GREAT BRITAIN

BONFIGLIOLI UK Ltd
Unit 3 Colemeadow Road - North Moons Moat
Redditch, Worcestershire B98 9PB
Tel. (+44) 1527 65022 - Fax (+44) 1527 61995
www.bonfiglioli.co.uk - marwaha@bonfiglioli.com

BONFIGLIOLI (UK) LIMITED

5 Grosvenor Grange - Woolston - Warrington, Cheshire WA1 4SF
Tel. (+44) 1925 852667 - Fax (+44) 1925 852668
www.bonfiglioliuk.co.uk - sales@bonfiglioliuk.co.uk

GREECE

BONFIGLIOLI HELLAS S.A.
O.T. 48A T.O. 230 - C.P. 570 22 Industrial Area - Thessaloniki
Tel. (+30) 2310 796456 - Fax (+30) 2310 795903
www.bonfiglioli.gr - info@bonfiglioli.gr

HOLLAND

ELSTO AANDRIJFTECHNIEK
Loosterweg, 7 - 2215 TL Voorhout
Tel. (+31) 252 219 123 - Fax (+31) 252 231 660
www.elsto.nl - imfo@elsto.nl

HUNGARY

AGISYS AGITATORS & TRANSMISSIONS Ltd
2045 Törökbálint, Tó u.2. Hungary
Tel. +36 23 50 11 50 - Fax +36 23 50 11 59
www.agisys.hu - info@agisys.com

INDIA

BONFIGLIOLI TRANSMISSIONS PVT Ltd.
PLOT AC7-AC11 Sidco Industrial Estate
Thirumudivakkam - Chennai 600 044
Tel. +91(0)44 24781035 / 24781036 / 24781037
Fax +91(0)44 24780091 / 24781904
www.bonfiglioli.co.in - bonfig@vsnl.com

NEW ZEALAND

SAECO BEARINGS TRANSMISSION
36 Hastie Avenue, Mangere
Po Box 22256, Otahuhu - Auckland
Tel. +64 9 634 7540 - Fax +64 9 634 7552
mark@saeco.co.nz

POLAND

POLPACK Sp. z o.o. - Ul. Chrobrego 135/137 - 87100 Torun
Tel. 0048.56.6559235 - 6559236 - Fax 0048.56.6559238
www.polpack.com.pl - polpack@polpack.com.pl

RUSSIA

FAM
57, Maly prospekt, V.O. - 199048, St. Petersburg
Tel. +7 812 3319333 - Fax +7 812 3271454
www.fam-drive.ru - info@fam-drive.ru

SPAIN

TECNOTRANS SABRE S.A.
Pol. Ind. Zona Franca sector C, calle F, nº6 08040 Barcelona
Tel. (+34) 93 4478400 - Fax (+34) 93 3360402
www.tecnotrans.com - tecnotrans@tecnotrans.com

SOUTH AFRICA

BONFIGLIOLI POWER TRANSMISSION Pty Ltd.
55 Galaxy Avenue, Linbro Business Park - Sandton
Tel. (+27) 11 608 2030 OR - Fax (+27) 11 608 2631
www.bonfiglioli.co.za - bonfigsales@bonfiglioli.co.za

SWEDEN

BONFIGLIOLI SKANDINAVIEN AB
Kontorsgatan - 234 34 Lomma
Tel. (+46) 40 412545 - Fax (+46) 40 414508
www.bonfiglioli.se - info@bonfiglioli.se

THAILAND

K.P.T MACHINERY (1993) CO.LTD.
259/83 Soi Phiboonves, Sukhumvit 71 Rd. Phrakonong-nur,
Wattana, Bangkok 10110
Tel. 0066.2.3913030/7111998
Fax 0066.2.7112852/3811308/3814905
www.kpt-group.com - sales@kpt-group.com

USA

BONFIGLIOLI USA INC
1000 Worldwide Boulevard - Hebron, KY 41048
Tel.: (+1) 859 334 3333 - Fax: (+1) 859 334 8888
www.bonfiglioliusa.com
industrialsales@bonfiglioliusa.com
mobilesales@bonfiglioliusa.com

VENEZUELA

MAQUINARIA Y ACCESORIOS IND.-C.A.
Calle 3B - Edif. Comindu - Planta Baja - Local B
La Urbina - Caracas 1070
Tel. 0058.212.2413570 / 2425268 / 2418263
Fax 0058.212.2424552
Tlx 24780 Maica V
www.maica-ve.com - maica@telcel.net.ve

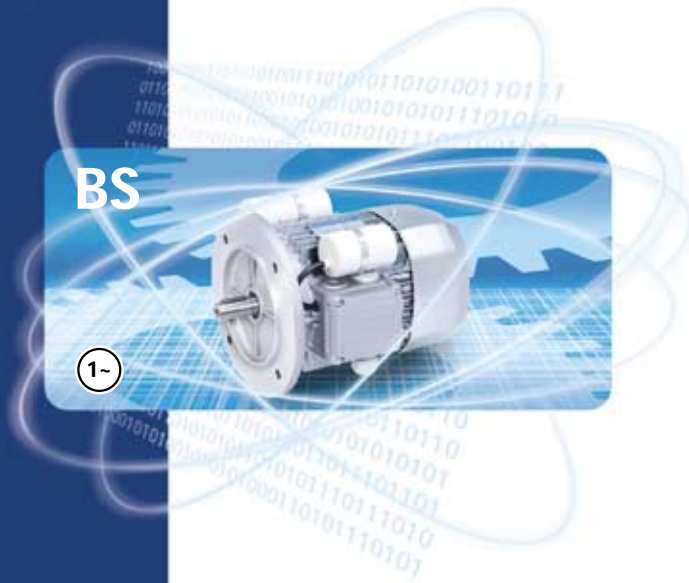

www.bonfiglioli.com

 **BONFIGLIOLI**